



**CATALOGO
CATALOGUE**

**Isolatori e accessori
di cablaggio**

Isolators and wiring accessories

2025/26





Meta[®]

International Trademark
registration n°
183536



ISOLATORI E ACCESSORI DI CABLAGGIO

META è presente da oltre vent'anni sul mercato Italiano ed internazionale con un'ampia gamma di isolatori elettrici e accessori di cablaggio, studiati per garantire ai propri clienti la massima versatilità di utilizzo e la sicurezza di un prodotto testato sul campo.

Gli isolatori **META** sono prodotti in materiale poliestere rinforzato con fibra di vetro, caratterizzato da:

- Totale assenza di alogeni.
- Elevato grado di isolamento elettrico e di resistenza meccanica.
- Grado di infiammabilità V0 secondo la norma UL94.
- Classe di rischio HL3 per opacità e tossicità dei fumi emessi, in conformità allo standard EN 45545-2 relativo al settore ferroviario.

I nostri prodotti sono stati testati presso il laboratorio certificato "INTEK SPA" per verificarne le qualità di resistenza meccanica ed elettrica, seguendo le specifiche contenute nelle norme di settore.

I valori di riferimento ottenuti dalle prove sono riportati nelle tabelle tecniche alle pagine seguenti.



LOW VOLTAGE INSULATORS AND ELECTRIC PANEL BOARD COMPONENTS

META is an Italy based company operating on Italian and international markets for over 20 years. It offers a wide range of low voltage stand-off insulators and electric panel board components, created to be the best choice in terms of quality and reliability.

META insulators are manufactured from a halogen-free, fiberglass-reinforced polyester moulded compound (BMC) with the following features:

- High Mechanical Strength and Excellent Insulation Capacity.
- Very high resistance to leakage current
- Classified V0 according to UL94 for self-extinguishing materials

The BMC compound we use has been classified hazard level 3 (HL3) according to EN 45545-2 standard for railway applications.

Our products have been tested by UL recognized "INTEK SPA" laboratory in order to verify their mechanical and electrical features; resulting parameters are displayed in the following pages.

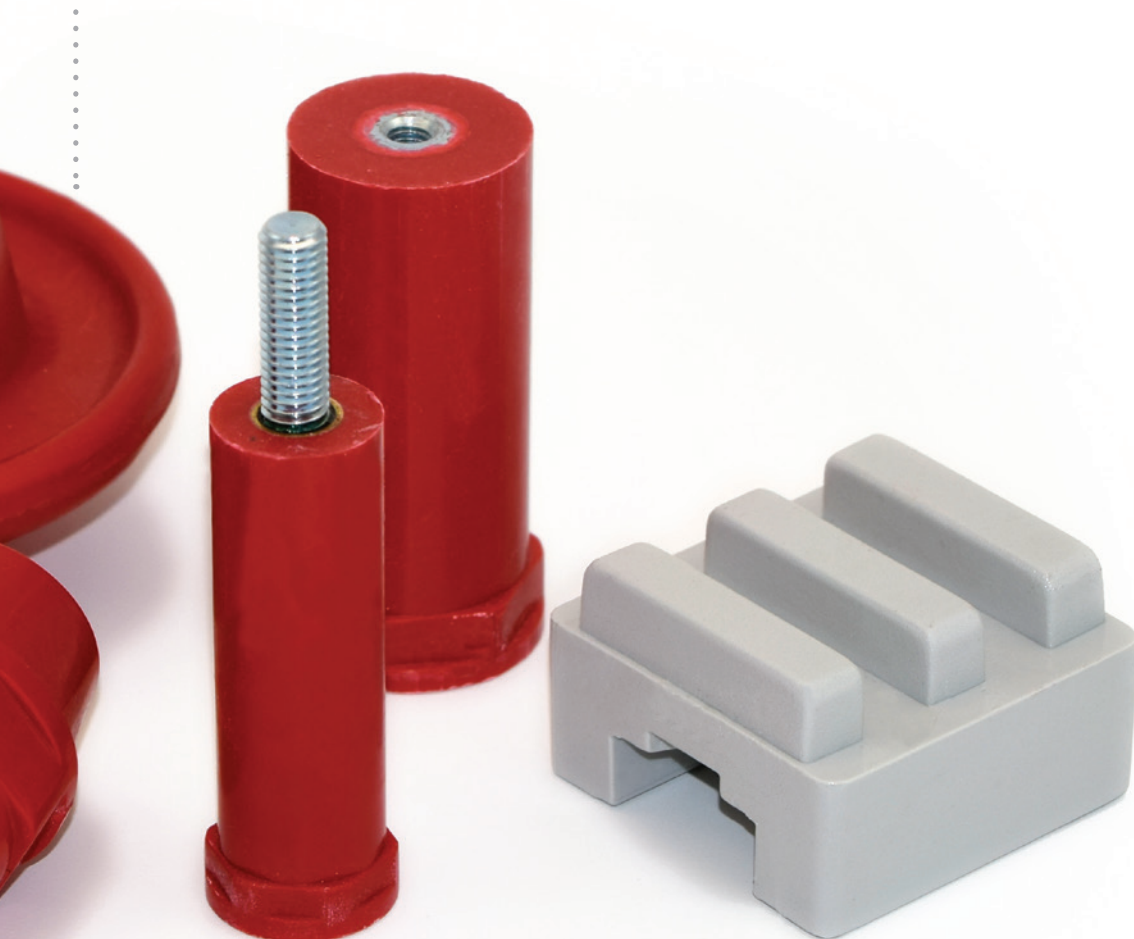

Settore Industriale

Industrial sector

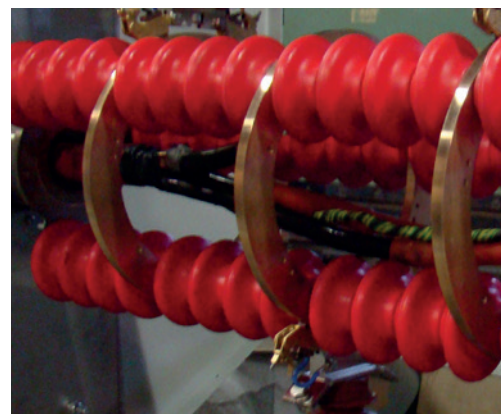
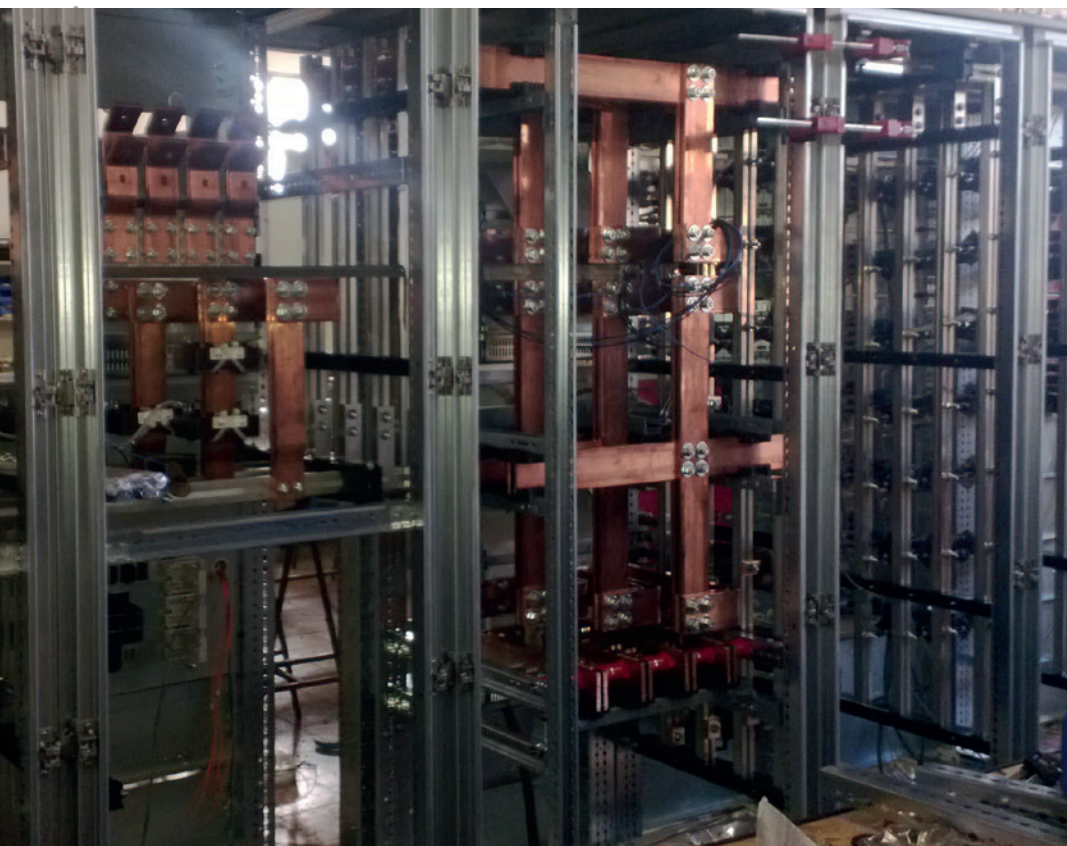

Isolatori e Portasbarre

Stand-off insulators and bus-bar supports

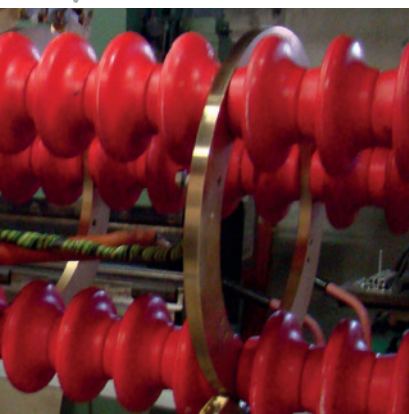

TIPO TYPE	DESCRIZIONE DESCRIPTION	PAGINE PAGES
GM	ISOLATORI DISTANZIATORI SERIE TRADIZIONALE <i>TRADITIONAL STAND-OFF INSULATORS</i>	6
GD	ISOLATORI DISTANZIATORI SERIE RINFORZATA <i>STRONG SHAPE STAND-OFF INSULATORS</i>	8
SC	COLONNINE DISTANZIALI Ø 20mm <i>CYLINDRICAL SPACING INSULATORS Ø20MM</i>	10
ST	COLONNINE DISTANZIALI Ø 30mm <i>CYLINDRICAL SPACING INSULATORS Ø30MM</i>	13
SD	COLONNINE DISTANZIALI Ø 40mm <i>CYLINDRICAL SPACING INSULATORS Ø40MM</i>	15
GH	ISOLATORI A CAMPANA <i>PETTICOAT INSULATORS</i>	17
GY GX	ISOLATORI A CAMPANA PER M.T. <i>PETTICOAT INSULATORS FOR H.V.</i>	18
OC OD	ISOLATORI PASSANTI <i>PASSING INSULATORS</i>	19
IS	PORTASBARRE A PETTINE <i>BUS-BAR SUPPORTS</i>	20

I dati contenuti nelle tabelle tecniche riportano valori medi ricavati dai test effettuati in laboratorio. I prodotti descritti nel presente catalogo devono essere utilizzati solo da personale qualificato, secondo le applicazioni specifiche al quale sono destinati.

All products in this catalogue must be used by qualified personnel only, for their designated purpose.

Isolatori distanziatori serie tradizionale

Traditional Stand-off insulators

GM



Disponibili in diverse altezze e provvisti di inserti filettati da M4 a M16, sono adatti all'utilizzo come supporti isolanti di parti elettricamente attive.

Realizzati per stampaggio a compressione in resina poliestere con fibre di vetro, garantiscono nel tempo un'elevata resistenza alle sollecitazioni elettriche e meccaniche.

Tutti gli articoli della serie sono ordinabili con viti senza testa premontate, come descritto in tabella a pag.7.

Available in a wide range of different heights and provided with threaded inserts from M4 to M16, these items are suitable for being used as isolating supports in busbar systems. This range of insulators is made up of fiberglass-reinforced polyester by compression moulding, to ensure long term endurance to both mechanical and electrical stresses. All items can be ordered with pre mounted headless screws, as showed in the table on page 7.

CARATTERISTICHE TECNICHE/FEATURES

Temperatura di esercizio Working temperature -40°C + 130°C
Classe di infiammabilità Flammability Rating UL 94 V0
Resistenza all'arco Arc resistance ASTM D-495 ≥ 180 sec.
Assorbimento acqua Water absorption ISO 62 ≤ 0,20%
Rigidità dielettrica Dielectric strength ASTM D 149/ IEC 60243 17 kV/mm
Resistenza alla traccia (CTI) Track resistance (CTI) IEC 60112 600 V/ PLC 0
Resistenza al glow wire Glow-wire test IEC 695-2-1 960°C

Altezza Height	Filettatura	Codici (da - a) Codes (from - to)	Carichi di rottura / Breaking loads			Tensione di esercizio Operating voltage	
			Trazione Tensile daN	Coppia Max di serr. Tightening torques N x mt.	Flessione Cantilever daN	c.a. a.c. V.	c.c. d.c. V.
15mm	M4	GP011-GP013	100	2,5	50	250	300
16 mm	M4	GM011-GM014	100	3	100	400	500
20mm	M4	GM021-GM024	100	3	150	600	800
20mm	M5	GM031-GM034	150	6	100	600	800
20mm	M6	GM041-GM044	150	6	80	600	800
25mm	M4	GM051-GM054	100	3	170	600	800
25mm	M5	GM061-GM064	150	6	150	600	800
25mm	M6	GM071-GM074	200	6	100	600	800
30mm	M6	GM081-GM084	300	10	300	600	800
30mm	M8	GM091-GM094	600	25	350	600	800
30mm	M10	GM101-GM104	600	30	350	600	800
34mm	M6	GM111-GM114	300	10	350	1000	1200
34mm	M8	GM121-GM127	600	25	450	1000	1200
34mm	M10	GM131-GM137	750	30	400	1000	1200
40mm	M6	GM261-GM264	500	10	500	1000	1200
40mm	M8	GM271-GM274	600	25	450	1000	1200
40mm	M10	GM281-GM284	850	40	450	1000	1200
50mm	M6	GM141-GM147	600	10	500	2000	2500
50mm	M8	GM151-GM157	800	25	450	2000	2500
50mm	M10	GM161-GM167	1000	50	500	2000	2500
63mm	M6	GM171-GM177	750	10	600	3000	3500
63mm	M8	GM181-GM187	1000	25	600	3000	3500
63mm	M10	GM191-GM197	1200	50	600	3000	3500
75mm	M8	GM201-GM207	1300	25	600	5000	7500
75mm	M10	GM211-GM217	1400	50	650	5000	7500
75mm	M12	GM221-GM227	1500	85	700	5000	7500
100mm	M12	GM241-GM247	1500	85	800	8000	10000
100mm	M16	GM251-GM257	1500	100	1100	8000	10000

Valore dei carichi di rottura = +/- 10%

Value of breaking charges = +/- 10%

1 daN = 1 Kg

VERSIONI/VERSIONS

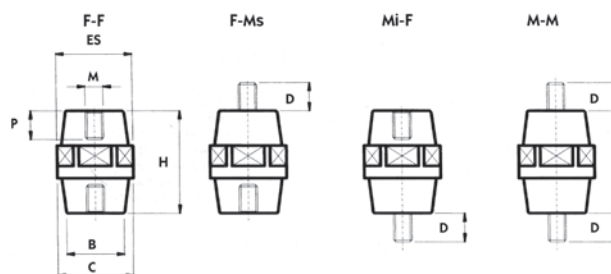

(*) Le confezioni sono riferite alle versioni F-F (senza viti).
The packing refers to F-F versions (no screws).

(*) **GM001 - GM004**
GP011 - GP013

Poliammide 6 caricato con fibre di vetro.
Fiberglass reinforced polyamide.

Versioni/Versions				Dimensioni/Dimensions							Conf./pezzi (*)
Codici/Codes											pcs./pack (*)
F-F	F-Ms	Mi-F	M-M	H	ES	B	C	M	P	D	N°
GM001	GM002	GM003	GM004	12	8	7,8	8	3	3	8	100
GP011	GP012		GP013	15	14	12		4	4	12	100
GM011	GM012	GM013	GM014	16	14	13	15	4	4	12	50
GM021	GM022	GM023	GM024	20	17	15	19	4	5	12	50
GM031	GM032	GM033	GM034	20	17	15	19	5	5	12	50
GM041	GM042	GM043	GM044	20	17	15	19	6	5	12	50
GM051	GM052	GM053	GM054	25	19	16	21	4	7	12	50
GM061	GM062	GM063	GM064	25	19	16	21	5	7	14	50
GM071	GM072	GM073	GM074	25	19	16	21	6	7	14	50
GM081	GM082	GM083	GM084	30	30	27	34	6	8	25	128
GM091	GM092	GM093	GM094	30	30	27	34	8	8	25	128
GM101	GM102	GM103	GM104	30	30	27	34	10	8	25	128
GM111	GM112	GM113	GM114	34	32	28	36	6	10	25	72
GM121	GM122	GM123	GM124	34	32	28	36	8	10	25	72
	GM125	GM126	GM127	34	32	28	36	8	10	40	72
GM131	GM132	GM133	GM134	34	32	28	36	10	10	25	72
	GM135	GM136	GM137	34	32	28	36	10	10	40	72
GM261	GM262	GM263	GM264	40	36	29	40	6	10	25	72
GM271	GM272	GM273	GM274	40	36	29	40	8	10	25	72
GM281	GM282	GM283	GM284	40	36	29	40	10	10	25	72
GM141	GM142	GM143	GM144	50	36	29	40	6	15	25	36
	GM145	GM146	GM147	50	36	29	40	6	15	40	36
GM151	GM152	GM153	GM154	50	36	29	40	8	15	25	36
	GM155	GM156	GM157	50	36	29	40	8	15	40	36
GM161	GM162	GM163	GM164	50	36	29	40	10	15	25	36
	GM165	GM166	GM167	50	36	29	40	10	15	40	36
GM171	GM172	GM173	GM174	63	41	31	45	6	15	25	36
	GM175	GM176	GM177	63	41	31	45	6	15	40	36
GM181	GM182	GM183	GM184	63	41	31	45	8	15	25	36
	GM185	GM186	GM187	63	41	31	45	8	15	40	36
GM191	GM192	GM193	GM194	63	41	31	45	10	15	25	36
	GM195	GM196	GM197	63	41	31	45	10	15	40	36
GM201	GM202	GM203	GM204	75	50	36	55	8	15	25	25
	GM205	GM206	GM207	75	50	36	55	8	15	40	25
GM211	GM212	GM213	GM214	75	50	36	55	10	25	25	25
	GM215	GM216	GM217	75	50	36	55	10	25	40	25
GM221	GM222	GM223	GM224	75	50	36	55	12	25	30	25
	GM225	GM226	GM227	75	50	36	55	12	25	40	25
GM241	GM242	GM243	GM244	100	65	52	72	12	25	30	10
	GM245	GM246	GM247	100	65	52	72	12	25	40	10
GM251	GM252	GM253	GM254	100	65	52	72	16	30	30	10
	GM255	GM256	GM257	100	65	52	72	16	30	40	10

Isolatori distanziatori serie rinforzata

Strong shape stand-off insulators

GD



Disponibili in una gamma di altezze da 35 a 80 mm e con inserti filettati da M6 a M16, questi isolatori dal profilo più robusto sono adatti all'utilizzo come supporti isolanti di parti elettricamente attive. Realizzati per stampaggio a compressione in resina poliestere con fibre di vetro, garantiscono nel tempo un'elevata resistenza alle sollecitazioni elettriche e meccaniche. Tutti gli articoli della serie sono ordinabili con viti senza testa premontate, come descritto in tabella a pag.9.

Available in a range of heights between 35 and 80 mm and provided with threaded inserts from M6 to M16, this series of insulators presents a larger profile. This range of insulators are made up of fiberglass-reinforced polyester by compression moulding, to ensure long term endurance to both mechanical and electrical stresses. All items can be ordered with pre mounted headless screws, as showed in the table on page 9.

CARATTERISTICHE TECNICHE/FEATURES

Temperatura di esercizio Working temperature -40°C + 130°C
Classe di infiammabilità Flammability Rating UL 94 V0
Resistenza all'arco Arc resistance ASTM D-495 ≥ 180 sec.
Absorbimento acqua Water absorption ISO 62 ≤ 0,20%
Rigidità dielettrica Dielectric strength ASTM D 149/ IEC 60243 17 kV/mm
Resistenza alla traccia (CTI) Track resistance (CTI) IEC 60112 600 V/ PLC 0
Resistenza al glow wire Glow-wire test IEC 695-2-1 960°C

Altezza Height	Filettatura	Codici (da - a) Codes (from - to)	Carichi di rottura / Breaking loads			Tensione di esercizio Operating voltage	
			Trazione Tensile daN	Coppia Max di serr. Tightening torques N x mt.	Flessione Cantilever daN	c.a. a.c. V.	c.c. d.c. V.
35mm	M6	GD001-GD007	1100	10	650	1000	1400
35mm	M8	GD011-GD017	1200	25	700	1000	1400
35mm	M10	GD021-GD027	1300	50	500	1000	1400
40mm	M8	GD031-GD037	1200	25	800	1000	1400
40mm	M10	GD041-GD047	1300	50	500	1000	1400
40mm	M12	GD051-GD057	1500	85	800	1000	1400
45mm	M8	GD061-GD067	1200	25	800	1000	1400
45mm	M10	GD071-GD077	1300	50	600	1000	1400
45mm	M12	GD081-GD087	1500	85	750	1000	1400
50mm	M8	GD091-GD097	1300	25	750	1000	1400
50mm	M10	GD101-GD107	1500	50	750	1000	1400
50mm	M12	GD111-GD117	1500	85	850	1000	1400
55mm	M8	GD121-GD127	1300	25	750	2000	2500
55mm	M10	GD131-GD137	1500	50	750	2000	2500
55mm	M12	GD141-GD147	1500	85	800	2000	2500
60mm	M8	GD151-GD157	1500	25	700	3000	4000
60mm	M10	GD161-GD167	1600	50	750	3000	4000
60mm	M12	GD171-GD177	1800	85	750	3000	4000
70mm	M12	GD181-GD187	1800	85	900	4000	5000
70mm	M16	GD191-GD197	2000	100	1500	4000	5000
75mm	M10	GD241-GD247	1600	50	750	4000	5000
75mm	M12	GD251-GD257	1800	85	1100	4000	5000
80mm	M12	GD201-GD207	1800	85	1100	4000	5000

Valore dei carichi di rottura = +/- 10%
Value of breaking charges = +/- 10%

1 daN = 1 Kg

VERSIONI/VERSIONS

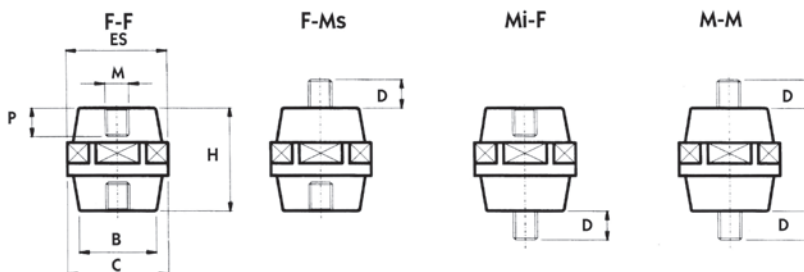

(*) Le confezioni sono riferite alle versioni F-F (senza viti).
The packing refers to F-F versions (no screws).

Versioni/Versions Codici/Codes				Dimensioni/Dimensions							Conf./pezzi (*) pcs./pack (*)
F-F	F-Ms	Mi-F	M-M	H	ES	B	C	M	P	D	N°
GD001	GD002	GD003	GD004	35	41	35	46	6	10	25	72
	GD005	GD006	GD007	35	41	35	46	6	10	40	72
GD011	GD012	GD013	GD014	35	41	35	46	8	10	25	72
	GD015	GD016	GD017	35	41	35	46	8	10	40	72
GD021	GD022	GD023	GD024	35	41	35	46	10	10	25	72
	GD025	GD026	GD027	35	41	35	46	10	10	40	72
GD031	GD032	GD033	GD034	40	46	40	50	8	10	25	25
	GD035	GD036	GD037	40	46	40	50	8	10	40	25
GD041	GD042	GD043	GD044	40	46	40	50	10	10	25	25
	GD045	GD046	GD047	40	46	40	50	10	10	40	25
GD051	GD052	GD053	GD054	40	46	40	50	12	12	25	25
	GD055	GD056	GD057	40	46	40	50	12	12	40	25
GD061	GD062	GD063	GD064	45	46	40	51	8	10	25	25
	GD065	GD066	GD067	45	46	40	51	8	10	40	25
GD071	GD072	GD073	GD074	45	46	40	51	10	10	25	25
	GD075	GD076	GD077	45	46	40	51	10	10	40	25
GD081	GD082	GD083	GD084	45	46	40	51	12	12	25	25
	GD085	GD086	GD087	45	46	40	51	12	12	40	25
GD091	GD092	GD093	GD094	50	50	44	56	8	15	25	25
	GD095	GD096	GD097	50	50	44	56	8	15	40	25
GD101	GD102	GD103	GD104	50	50	44	56	10	15	25	25
	GD105	GD106	GD107	50	50	44	56	10	15	40	25
GD111	GD112	GD113	GD114	50	50	44	56	12	15	25	25
	GD115	GD116	GD117	50	50	44	56	12	15	40	25
GD121	GD122	GD123	GD124	55	55	46	62	8	15	25	20
	GD125	GD126	GD127	55	55	46	62	8	15	40	20
GD131	GD132	GD133	GD134	55	55	46	62	10	15	25	20
	GD135	GD136	GD137	55	55	46	62	10	15	40	20
GD141	GD142	GD143	GD144	55	55	46	62	12	15	25	20
	GD145	GD146	GD147	55	55	46	62	12	15	40	20
GD151	GD152	GD153	GD154	60	55	48	62	8	15	25	20
	GD155	GD156	GD157	60	55	48	62	8	15	40	20
GD161	GD162	GD163	GD164	60	55	48	62	10	15	25	20
	GD165	GD166	GD167	60	55	48	62	10	15	40	20
GD171	GD172	GD173	GD174	60	55	48	62	12	15	25	20
	GD175	GD176	GM177	60	55	48	62	12	15	40	20
GD181	GD182	GD183	GD184	70	65	52	72	12	25	25	16
	GD185	GD186	GD187	70	65	52	72	12	25	40	16
GD191	GD192	GD193	GD194	70	65	52	72	16	25	25	16
	GD195	GD196	GD197	70	65	52	72	16	25	40	16
GD241	GD242	GD243	GD244	75	65	52	72	10	25	25	16
	GD245	GD246	GD247	75	65	52	72	10	25	40	16
GD251	GD252	GD253	GD254	75	65	52	72	12	25	25	16
	GD255	GD256	GD257	75	65	52	72	12	25	40	16
GD201	GD202	GD203	GD204	80	65	52	72	12	25	25	16
	GD205	GD206	GD207	80	65	52	72	12	25	40	16

Colonnine distanziali Ø20 mm

Cylindrical stand-off insulators Ø20 mm

SC



Disponibili in una gamma di altezze da 16 a 70 mm e con inserti filettati da M4 a M8, questi isolatori dal profilo cilindrico presentano una fascia esagonale nella parte inferiore per consentire un facile montaggio.

Realizzati per stampaggio a compressione in resina poliestere con fibre di vetro, garantiscono nel tempo un'elevata resistenza alle sollecitazioni elettriche e meccaniche.

Tutti gli articoli della serie sono ordinabili con viti senza testa premontate, come riportato in tabella a pag 11-12.

Available in a range of heights between 16 and 70mm and provided with threaded inserts from M4 to M8, this series of cylindrical shape insulators is designed with a hexagonal bottom band for an easy fitting. These insulators are made up of fiber-glass-reinforced polyester by compression moulding, to ensure long term endurance to both mechanical and electrical stresses. All items can be ordered with pre mounted headless screws, as showed in the table on pages 11-12.

CARATTERISTICHE TECNICHE/FEATURES

Coppia max. di serraggio: M4=3N/m M5=6N/m M6=8N/m M8=8N/m

Tightening torques: M4=3N/m M5=6N/m M6=8N/m M8=8N/m

Temperatura di esercizio Working temperature -40°C + 130°C
Classe di infiammabilità Flammability Rating UL 94 V0
Resistenza all'arco Arc resistance ASTM D-495 ≥ 180 sec.
Absorbimento acqua Water absorption ISO 62 ≤ 0,20%
Rigidità dielettrica Dielectric strength ASTM D 149/ IEC 60243 17 kV/mm
Resistenza alla traccia (CTI) Track resistance (CTI) IEC 60112 600 V/ PLC 0
Resistenza al glow wire Glow-wire test IEC 695-2-1 960°C

Altezza/Height	Codici (da - a) Codes (from - to)	Carichi di rottura / Breaking loads		Tensione di esercizio Operating voltage	
		Trazione Tensile daN	Flessione Cantilever daN	c.a. a.c. V.	c.c. d.c. V.
16mm	SC019-SC042	400	250	400	600
20mm	SC119-SC142	400	200	600	800
25mm	SC219-SC242	400	180	600	800
30mm	SC311-SC-334	400	150	600	800
35mm	SC411-SC434	400	150	800	800
40mm	SC511-SC534	400	130	1000	1400
45mm	SC611-SC634	400	130	1000	1400
50mm	SC711-SC734	400	100	1500	2000
55mm	SC811-SC826	400	100	1500	2000
60mm	SC919-SC934	400	80	1500	2000
65mm	SC1019-SC1034	400	75	1500	2000
70mm	SC1119-SC1134	400	75	1500	2000

Valore dei carichi di rottura = +/- 10%
Value of breaking charges = +/- 10%

1 daN = 1 Kg

VERSIONI/VERSIONS

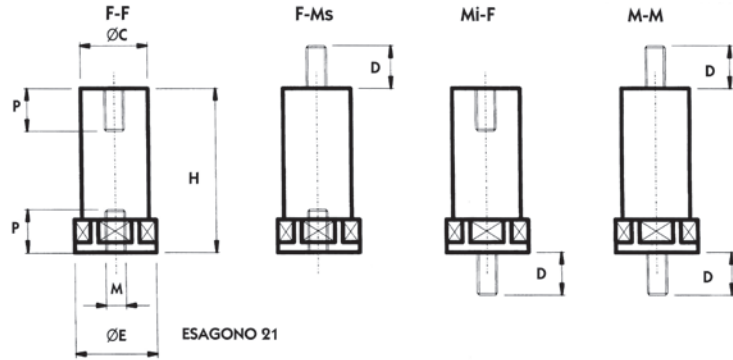

(*) Le confezioni sono riferite alle versioni F-F (senza viti).
The packing refers to F-F versions (no screws).

Versioni/Versions Codici/Codes				Dimensioni/Dimensions						Conf./pezzi (*) pcs./pack (*)
F-F	F-Ms	Mi-F	M-M	H	E	C	M	P	D	N°
SC019	SC020	SC021	SC022	16	23	20	5	4	10	50
	SC024	SC025	SC026	16	23	20	5	4	15	50
SC027	SC028	SC029	SC030	16	23	20	6	4	10	50
	SC032	SC033	SC034	16	23	20	6	4	15	50
SC035	SC036	SC037	SC038	16	23	20	8	4	15	50
	SC040	SC041	SC042	16	23	20	8	4	25	50
SC119	SC120	SC121	SC122	20	23	20	5	6	10	50
	SC124	SC125	SC126	20	23	20	5	6	15	50
SC127	SC128	SC129	SC130	20	23	20	6	6	10	50
	SC132	SC133	SC134	20	23	20	6	6	15	50
SC135	SC136	SC137	SC138	20	23	20	8	6	15	50
	SC140	SC141	SC142	20	23	20	8	6	25	50
SC219	SC220	SC221	SC222	25	23	20	5	8	10	50
	SC224	SC225	SC226	25	23	20	5	8	15	50
SC227	SC228	SC229	SC230	25	23	20	6	8	10	50
	SC232	SC233	SC234	25	23	20	6	8	15	50
SC235	SC236	SC237	SC238	25	23	20	8	8	15	50
	SC240	SC241	SC242	25	23	20	8	8	25	50
SC311	SC312	SC313	SC314	30	23	20	5	10	10	50
	SC316	SC317	SC318	30	23	20	5	10	15	50
SC319	SC320	SC321	SC322	30	23	20	6	10	15	50
	SC324	SC325	SC326	30	23	20	6	10	25	50
SC327	SC328	SC329	SC330	30	23	20	8	10	15	50
	SC332	SC333	SC334	30	23	20	8	10	25	50

Colonnine distanziali Ø20 mm

Cylindrical stand-off insulators Ø20 mm

SC

(*) Le confezioni sono riferite alle versioni F-F (senza viti).
The packing refers to F-F versions (no screws).

Versioni/Versions Codici/Codes				Dimensioni/Dimensions						Conf./pezzi (*) pcs./pack (*)
F-F	F-Ms	Mi-F	M-M	H	E	C	M	P	D	N°
SC411	SC412	SC413	SC414	35	23	20	5	10	10	50
	SC416	SC417	SC418	35	23	20	5	10	15	50
SC419	SC420	SC421	SC422	35	23	20	6	10	15	50
	SC424	SC425	SC426	35	23	20	6	10	25	50
SC427	SC428	SC429	SC430	35	23	20	8	10	15	50
	SC432	SC433	SC434	35	23	20	8	10	25	50
SC511	SC512	SC513	SC514	40	23	20	5	10	10	50
	SC516	SC517	SC518	40	23	20	5	10	15	50
SC519	SC520	SC521	SC522	40	23	20	6	10	15	50
	SC524	SC525	SC526	40	23	20	6	10	25	50
SC527	SC528	SC529	SC530	40	23	20	8	10	15	50
	SC532	SC533	SC534	40	23	20	8	10	25	50
SC611	SC612	SC613	SC614	45	23	20	5	10	10	50
	SC616	SC617	SC618	45	23	20	5	10	15	50
SC619	SC620	SC621	SC622	45	23	20	6	10	15	50
	SC624	SC625	SC626	45	23	20	6	10	25	50
SC627	SC628	SC629	SC630	45	23	20	8	10	15	50
	SC632	SC633	SC634	45	23	20	8	10	25	50
SC711	SC712	SC713	SC714	50	23	20	5	10	10	25
	SC716	SC717	SC718	50	23	20	5	10	15	25
SC719	SC720	SC721	SC722	50	23	20	6	10	15	25
	SC724	SC725	SC726	50	23	20	6	10	25	25
SC727	SC728	SC729	SC730	50	23	20	8	10	15	25
	SC732	SC733	SC734	50	23	20	8	10	25	25
SC811	SC812	SC813	SC814	55	23	20	5	10	10	25
	SC816	SC817	SC818	55	23	20	5	10	15	25
SC819	SC820	SC821	SC822	55	23	20	6	10	15	25
	SC824	SC825	SC826	55	23	20	6	10	25	25
SC919	SC920	SC921	SC922	60	23	20	6	10	15	25
	SC924	SC925	SC926	60	23	20	6	10	25	25
SC927	SC928	SC929	SC930	60	23	20	8	10	15	25
	SC932	SC933	SC934	60	23	20	8	10	25	25
SC1019	SC1020	SC1021	SC1022	65	23	20	6	10	15	25
	SC1024	SC1025	SC1026	65	23	20	6	10	25	25
SC1027	SC1028	SC1029	SC1030	65	23	20	8	10	15	25
	SC1032	SC1033	SC1034	65	23	20	8	10	25	25
SC1119	SC1120	SC1121	SC1122	70	23	20	6	10	15	25
	SC1124	SC1125	SC1126	70	23	20	6	10	25	25
SC1127	SC1128	SC1129	SC1130	70	23	20	8	10	15	25
	SC1132	SC1133	SC1134	70	23	20	8	10	25	25

Colonnine distanziali Ø30 mm

Cylindrical stand-off insulators Ø30 mm



ST



Disponibili in una gamma di altezze da 30 a 70 mm e con inserti filettati da M6 a M8, questi isolatori dal profilo cilindrico presentano una fascia esagonale nella parte inferiore per consentire un facile montaggio.

Realizzati per stampaggio a compressione in resina poliestere con fibre di vetro, garantiscono nel tempo un'elevata resistenza alle sollecitazioni elettriche e meccaniche.

Tutti gli articoli della serie sono ordinabili con viti senza testa premontate, come descritto in tabella a pag.14.

Available in a range of heights between 30 and 70mm and provided with threaded inserts from M6 to M8, this series of cylindrical shape insulators is designed with a hexagonal bottom band for an easy fitting.

These insulators are made up of fiberglass-reinforced polyester by compression moulding, to ensure long term endurance to both mechanical and electrical stresses.

All items can be ordered with pre mounted headless screws, as showed in the table on page 14.

CARATTERISTICHE TECNICHE/FEATURES

Coppia max. di serraggio: M6=8N/m M8=25N/m

Tightening torques: M6=8N/m M8=25N/m

Temperatura di esercizio Working temperature -40°C + 130°C
Classe di infiammabilità Flammability Rating UL 94 V0
Resistenza all'arco Arc resistance ASTM D-495 ≥ 180 sec.
Assorbimento acqua Water absorption ISO 62 ≤ 0,20%
Rigidità dielettrica Dielectric strength ASTM D 149/ IEC 60243 17 kV/mm
Resistenza alla traccia (CTI) Track resistance (CTI) IEC 60112 600 V/ PLC 0
Resistenza al glow wire Glow-wire test IEC 695-2-1 960°C

Altezza/Height	Codici (da - a) Codes (from - to)	Carichi di rottura Breaking loads		Tensione di esercizio Operating voltage	
		Trazione Tensile daN	Flessione Cantilever daN	c.a. a.c. V.	c.c. d.c. V.
30mm	ST011-ST026	900	450	600	800
35mm	ST119-ST126	900	450	800	1000
40mm	ST219-ST226	900	350	1000	1400
50mm	ST419-ST426	900	250	1500	2000
55mm	ST519-ST526	900	250	1500	2000
60mm	ST611-ST626	900	150	1500	2000
70mm	ST819-ST826	900	150	1500	2000

Valore dei carichi di rottura = +/- 10%

Value of breaking charges = +/- 10%

1 daN = 1 Kg

Colonnine distanziali Ø30 mm

Cylindrical stand-off insulators Ø30 mm

ST

VERSIONI/VERSIONS

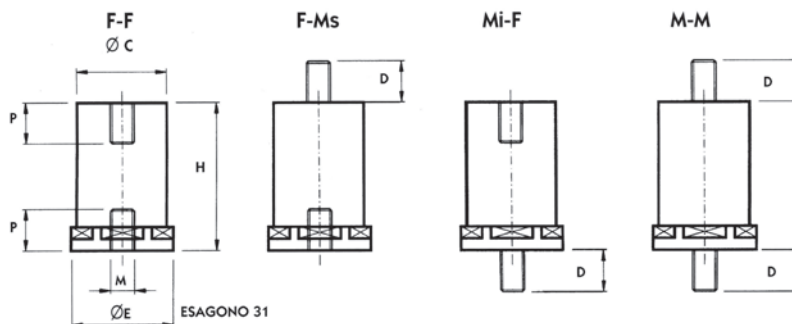

(*) Le confezioni sono riferite alle versioni F-F (senza viti).
The packing refers to F-F versions (no screws).

Versioni/Versions Codici/Codes				Dimensioni/Dimensions						Conf./pezzi (*) pcs./pack (*)
F-F	F-Ms	Mi-F	M-M	H	E	C	M	P	D	N°
ST011	ST012	ST013	ST014	30	34	30	6	8	15	128
	ST016	ST017	ST018	30	34	30	6	8	25	128
ST019	ST020	ST021	ST022	30	34	30	8	8	15	128
	ST024	ST025	ST026	30	34	30	8	8	25	128
ST119	ST120	ST121	ST122	35	34	30	8	10	15	128
	ST124	ST125	ST126	35	34	30	8	10	25	128
ST219	ST220	ST221	ST222	40	34	30	8	10	15	128
	ST224	ST225	ST226	40	34	30	8	10	25	128
ST419	ST420	ST421	ST422	50	34	30	8	15	15	64
	ST424	ST425	ST426	50	34	30	8	15	25	64
ST519	ST520	ST521	ST522	55	34	30	8	15	15	64
	ST524	ST525	ST526	55	34	30	8	15	25	64
ST611	ST612	ST613	ST614	60	34	30	6	15	15	64
	ST616	ST617	ST618	60	34	30	6	15	25	64
ST619	ST620	ST621	ST622	60	34	30	8	15	15	64
	ST624	ST625	ST626	60	34	30	8	15	25	64
ST819	ST820	ST821	ST822	70	34	30	8	15	15	64
	ST824	ST825	ST826	70	34	30	8	15	25	64

Colonnine distanziali Ø40 mm

Cylindrical stand-off insulators Ø40 mm



SD



Disponibili in una gamma di altezze da 30 a 70 mm e con inserti filettati da M10 a M12, questi isolatori dal profilo cilindrico presentano una fascia esagonale nella parte inferiore per consentire un facile montaggio.

Realizzati per stampaggio a compressione in resina poliestere con fibre di vetro, garantiscono nel tempo un'elevata resistenza alle sollecitazioni elettriche e meccaniche.

Tutti gli articoli della serie sono ordinabili con viti senza testa premontate, come riportato in tabella a pag.16.

Available in a range of heights between 16 and 70mm and provided with threaded inserts from M10 to M12, this series of cylindrical shape insulators is designed with a hexagonal bottom band for an easy fitting.

These insulators are made up of fiber-glass-reinforced polyester by compression moulding, to ensure long term endurance to both mechanical and electrical stresses.

All items can be ordered with pre mounted headless screws, as showed in the table on page 16.

CARATTERISTICHE TECNICHE/FEATURES

Coppia max. di serraggio: M8=25N/m M10=40N/m M12=60N/m

Tightening torques: M8=25N/m M10=40N/m M12=60N/m

Temperatura di esercizio Working temperature -40°C + 130°C
Classe di infiammabilità Flammability Rating UL 94 V0
Resistenza all'arco Arc resistance ASTM D-495 ≥ 180 sec.
Assorbimento acqua Water absorption ISO 62 ≤ 0,20%
Rigidità dielettrica Dielectric strength ASTM D 149/ IEC 60243 17 kV/mm
Resistenza alla traccia (CTI) Track resistance (CTI) IEC 60112 600 V/ PLC 0
Resistenza al glow wire Glow-wire test IEC 695-2-1 960°C

Altezza/Height	Codici (da - a) Codes (from - to)	Carichi di rottura / Breaking loads		Tensione di esercizio Operating voltage	
		Trazione Tensile daN	Flessione Cantilever daN	c.a. a.c. V.	c.c. d.c. V.
35mm	SD119-SD122	1000	700	800	1000
40mm	SD219-SD222	1000	600	1000	1400
50mm	SD419-SD422	1000	600	1500	2000
60mm	SD619-SD622	1000	450	1500	2000
70mm	SD819-SD822	1000	450	1500	2000

Valore dei carichi di rottura = +/- 10%
 Value of breaking charges = +/- 10%

1 daN = 1 Kg

Colonnine distanziali Ø40 mm

Cylindrical stand-off insulators Ø40 mm

SD

VERSIONI/VERSIONS

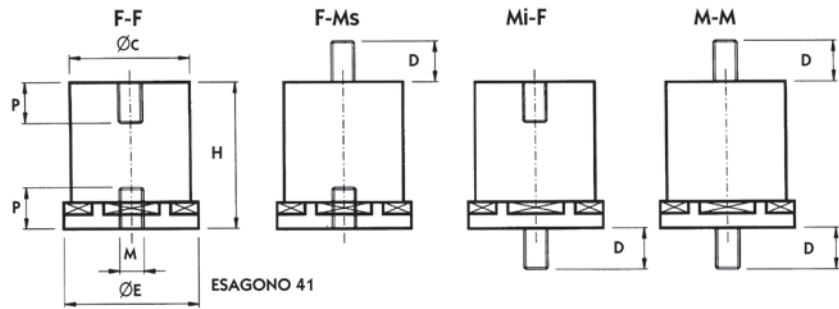

(*) Le confezioni sono riferite alle versioni F-F (senza viti).
The packing refers to F-F versions (no screws).

Versioni/Versions Codici/Codes				Dimensioni/Dimensions						Conf./pezzi (*) pcs./pack (*)
F-F	F-Ms	Mi-F	M-M	H	E	C	M	P	D	N°
SD119	SD120	SD121	SD122	35	45	40	10	10	25	72
SD219	SD220	SD221	SD222	40	45	40	10	10	25	72
SD419	SD420	SD421	SD422	50	45	40	10	15	25	36
SD619	SD620	SD621	SD622	60	45	40	10	15	25	36
SD819	SD820	SD821	SD822	70	45	40	10	15	25	36

Isolatori a campana

Petticoat Insulators



GH



Questo isolatore è adatto per un utilizzo in ambienti particolarmente umidi o polverosi, grazie alla suo profilo che facilita il gocciolamento e non permette il deposito continuo di polveri. Tutti gli articoli della serie sono ordinabili con viti senza testa premontate come descritto nella tabella.

This type of insulator is suitable for being used in damp or dusty environments, thanks to its particular shape that helps water dripping and prevents from dust depositing. After a surface treatment, it can be used also outside. All items can be ordered with pre mounted headless screws, as showed in the table below.

CARATTERISTICHE TECNICHE/FEATURES

Temperatura di esercizio Working temperature -40°C + 130°C
Classe di infiammabilità Flammability Rating UL 94 V0
Resistenza all'arco Arc resistance ASTM D-495 ≥ 180 sec.
Assorbimento acqua Water absorption ISO 62 ≤ 0,20%
Rigidità dielettrica Dielectric strength ASTM D 149/ IEC 60243 17 kV/mm
Resistenza alla traccia (CTI) Track resistance (CTI) IEC 60112 600 V/ PLC 0
Resistenza al glow wire Glow-wire test IEC 695-2-1 960°C

Altezza/Height	Codici (da - a) Codes (from - to)	Carichi di rottura / Breating loads			Tensione di esercizio Operating voltage	
		Trazione Tensile	Torsione Twisting	Flessione Cantilever	c.a. a.c.	c.c. d.c.
52 mm	GH001 - GH031	2000 daN	10 daN x mt.	1600 daN	5000 V.	5000 V.

Valore dei carichi di rottura = +/- 10%
Value of breaking charges = +/- 10%

1 daN = 1 Kg

VERSIONI/VERSIONS

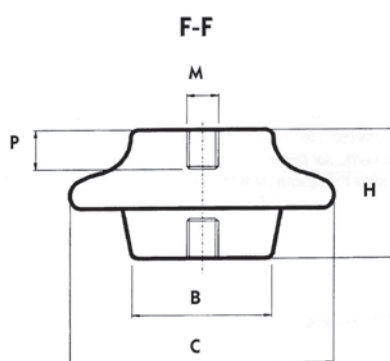

Versioni/Versions Codici/Codes	Dimensioni/Dimensions						Conf./pezzi (*) pcs./pack (*)
F-F	H	M	B	C	P	D	N°
GH001	52	8	52	100	16	25	12
GH011	52	10	52	100	16	30	12
GH021	52	12	52	100	16	35	12
GH031	52	16	52	100	16	40	12

Isolatori a campana per m.t.

Petticoat Insulators for h.v.

GY GX



Gli isolatori del tipo "a campana" con inserti in ottone possono essere sovrapposti per un uso in media tensione, come nello schema sotto riportato.

These petticoat shape insulators with brass threaded inserts can be fitted one above the other to be used in High Voltage, as showed in the scheme below.

CARATTERISTICHE TECNICHE/FEATURES

Elementi Elements	Altezza/Height	Codici (da - a) Codes (from - to)	Tensioni Voltage		Tensione di tenuta Withstand voltage	
			Nomin. Rated kV. a.c.	Eserc. Operating kV. a.c.	Freq.industriale Industrial freq. kV.	Impulsi Impulses kV.
1	52 mm	GX001 - GY001 - GX003	6	7,2	35	60
2	104 mm	GX011 - GY011 - GX013	10	12	40	75
3	156 mm	GX021 - GY021 - GX023	15	17,5	50	95
4	208 mm	GX031 - GY031 - GX033	20	24	65	125
5	260 mm	GX041 - GY041 - GX043	30	36	85	170

VERSIONI/VERSIONS

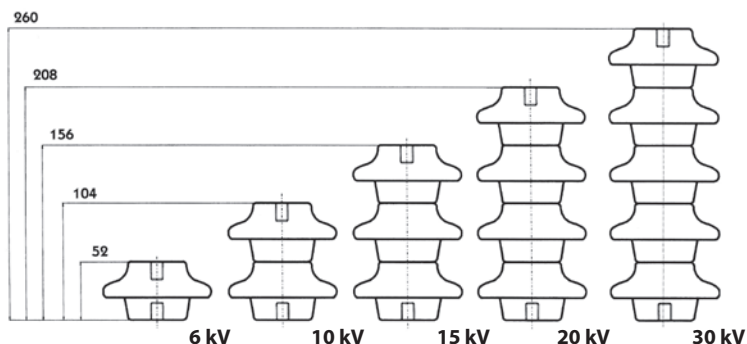

Temperatura di esercizio
Working temperature
-40°C + 130°C

Classe di infiammabilità
Flammability Rating
UL 94
V0

Resistenza all'arco
Arc resistance
ASTM D-495
≥ 180 sec.

Assorbimento acqua
Water absorption
ISO 62
≤ 0,20%

Rigidità dielettrica
Dielectric strength
ASTM D 149/ IEC 60243
17 kV/mm

Resistenza alla traccia (CTI)
Track resistance (CTI)
IEC 60112
600 V/ PLC 0

Resistenza al glow wire
Glow-wire test
IEC 695-2-1
960°C

Elementi Elements	Codice/Code	Altezza Height	Diametro Diameter	Filetto Thread	Tensione Kv Voltage Kv	Conf./pezzi pcs./pack
1	GX001	52	100	M 12	6	12
	GX003	52	100	M 14	6	12
	GY001	52	100	M 16	6	12
2	GX011	104	100	M 12	10	6
	GY011	104	100	M 16	10	6
3	GX021	156	100	M 12	15	6
	GY021	156	100	M 16	15	6
4	GX031	208	100	M 12	20	3
	GY031	208	100	M 16	20	3
5	GX041	260	100	M 12	30	3
	GX043	260	100	M 14	30	3
	GY041	260	100	M 16	30	3

OC OD

CARATTERISTICHE TECNICHE/FEATURES



Codici /Codes		Portata nominale Rated range A	Tensione d'esercizio Operating voltage V	Tensione di prova Test voltage kV	Dimensioni /Dimensions								
ROSSO RED	NERO BLACK				A	B	C	D	E	F	G	H	I
OC010	OD010	25	600	3	64	4	3	18	12	13	8,5	2,5	11
OC020	OD020	50	1000	4	77	6	5	23	13	13	12	3,5	16
OC030	OD030	80	1000	4	96	8	5	28	15	18	16	3,5	19
OC040	OD040	120	1000	4	110	10	5	32	18	21	18	4,5	22
OC050	OD050	200	1000	4	124	12	5	38	20	22	21	5	26
OC060	OD060	300	2000	5	147	16	7	43	25	27	26	5,5	31

DIMENSIONI/DIMENSIONS

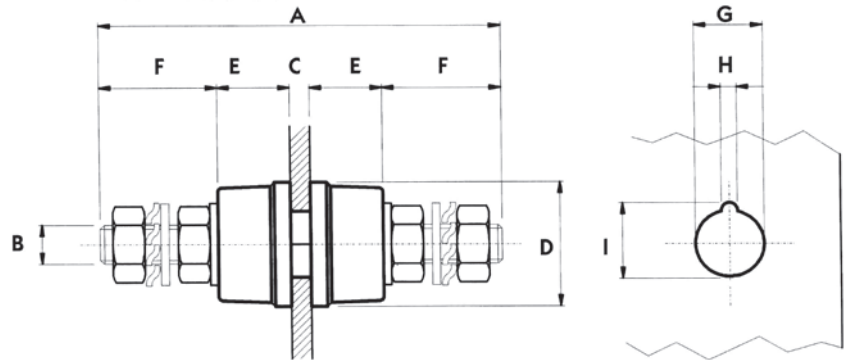

Portasbarre a pettine

Bus-bar supports

IS



MATERIALI PRIVI DI ALOGENI
HALOGEN FREE

PORTASBARRE ISOLANTI A PETTINE INSULATING BUS-BAR SUPPORTS

Tipo/Type	Dimens.				D N°
	A	B	C	D	
IS001	68	32	52	5,3	4
IS004	77	32	52	10,3	3
IS007	52	32	52	10,3	2

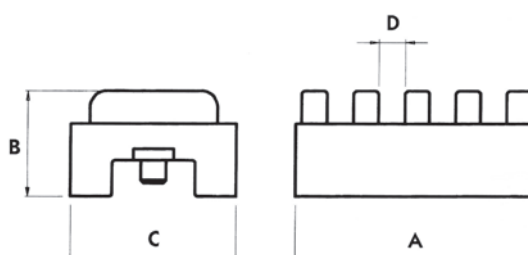

PROFILATO PER PORTASBARRE SUPPORTING IRON CHANNEL

Tipo/Type
IS101

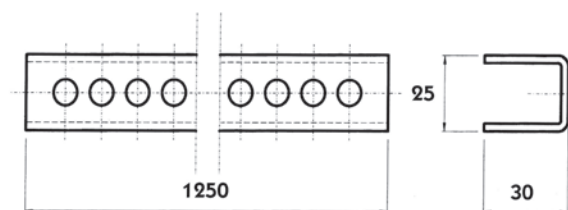

MATERIALI PRIVI DI ALOGENI
HALOGEN FREE

PERNO DI BLOCCAGGIO LOCKING PIN

Tipo/Type	Conf. pezzi/Pack pieces
IS401	50

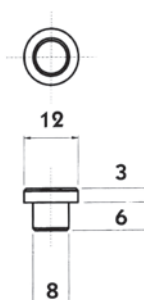

Portasbarre a pettine

Bus-bar supports

IS



MATERIALI PRIVI DI ALOGENI
HALOGEN FREE

CARATTERISTICHE TECNICHE/FEATURES

Dimens. Sbarra Bar dimensions	N. sbarre per fase - N. of bars per phase															
	1		2		3		4		1		2					
	Interasse Clearance		Materiale tirante Material tension rod		Interasse Clearance		Materiale tirante Material tension rod		Interasse Clearance		Materiale tirante Material tension rod					
C	D	A	B	A		B		A		B		A		B		
50	5	91	78	Fe/Iron		91	78	Fe/Iron		104	91	Ot/Brass		117	104	Ot/Brass
	6	91	78	Fe/Iron		91	78	Fe/Iron		104	91	Ot/Brass		130	104	Ot/Brass
	8	91	78	Fe/Iron		91	78	Fe/Iron		130	104	Ot/Brass		156	117	Ot/Brass
	10	91	78	Fe/Iron		104	91	Fe/Iron		143	104	Ot/Brass		156	117	Ot/Brass
60	5	91	78	Fe/Iron		91	78	Fe/Iron		104	91	Ot/Brass		117	104	Ot/Brass
	6	91	78	Fe/Iron		91	78	Fe/Iron		104	91	Ot/Brass		130	104	Ot/Brass
	8	91	78	Fe/Iron		91	78	Fe/Iron		130	104	Ot/Brass		156	117	Ot/Brass
	10	91	78	Fe/Iron		104	91	Fe/Iron		143	104	Ot/Brass		156	117	Ot/Brass
80	5	91	78	Fe/Iron		91	78	Fe/Iron		104	91	Ot/Brass		117	104	Ot/Brass
	6	91	78	Fe/Iron		91	78	Fe/Iron		104	91	Ot/Brass		130	104	Ot/Brass
	8	91	78	Fe/Iron		91	78	Fe/Iron		130	104	Ot/Brass		156	117	Ot/Brass
	10	91	78	Fe/Iron		104	91	Fe/Iron		143	104	Ot/Brass		156	117	Ot/Brass
100	5	91	78	Fe/Iron		91	78	Fe/Iron		104	91	Ot/Brass		117	104	Ot/Brass
	6	91	78	Fe/Iron		91	78	Fe/Iron		104	91	Ot/Brass		130	104	Ot/Brass
	8	91	78	Fe/Iron		91	78	Fe/Iron		130	104	Ot/Brass		156	117	Ot/Brass
	10	91	78	Fe/Iron		104	91	Fe/Iron		143	104	Ot/Brass		156	117	Ot/Brass
120	5	91	78	Fe/Iron		91	78	Fe/Iron		104	91	Ot/Brass		117	104	Ot/Brass
	6	91	78	Fe/Iron		91	78	Fe/Iron		104	91	Ot/Brass		130	104	Ot/Brass
	8	91	78	Fe/Iron		91	78	Fe/Iron		130	104	Ot/Brass		156	117	Ot/Brass
	10	91	78	Fe/Iron		104	91	Fe/Iron		143	104	Ot/Brass		156	117	Ot/Brass

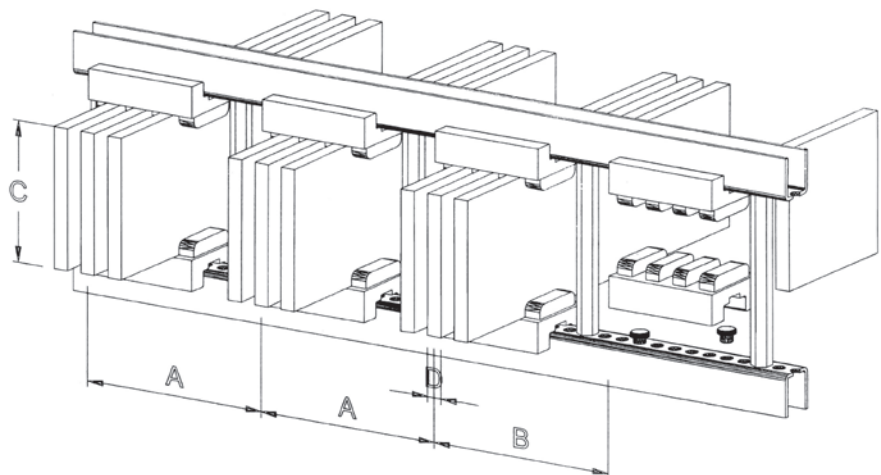

Portasbarre a pettine

Bus-bar supports

IS

DETERMINAZIONE DELLA DISTANZA "S" TRA I SUPPORTI IN FUNZIONE DELLA DISTANZA "A" FRA LE FASI E DELLE CORRENTI DI CORTO CIRCUITO
DISTANCE "S" DETERMINATION BETWEEN SUPPORTS CONSIDERING DISTANCE "A" BETWEEN PHASES AND THE SHORT-CIRCUIT.

A	CORRENTI DI CORTO CIRCUITO EFFICACE/R.M.S. SHORT-CIRCUIT						
	30	40	50	60	70	80	100
91	700	530	500				
104	800	550	520	490	400		
117		600	530	500	450	370	
130		650	540	510	480	400	280
143		700	550	520	500	430	310
156						450	340

Tutte le quote sono espresse in millimetri.

All the measures are expressed in millimetres.

La presente tabella è stata determinata prevedendo l'impiego del perno di bloccaggio tipo "IS 401"

The table has been made considering the use of the locking pin type "IS 401"

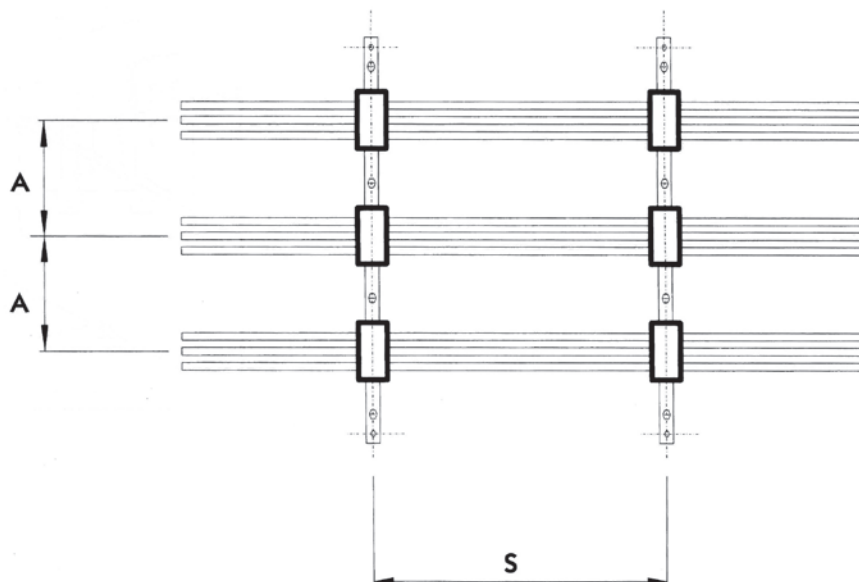

Caratteristiche tecniche del materiale

Material features



BMC RF 9/20

BMC RF 9/20 is a bulk moulding compound based on an unsaturated polyester resin, fire retardant grade, halogen-free, reinforced with glass fibres. This BMC has been developed for railway electrical application. Good mechanical properties and good fire protection grade are combined into the **BMC RF 9/20**.

BMC RF 9/20 complies with EN 45545-2 requirement set R22 HL3. **BMC RF 9/20** is formulated according to RoHS, REAC regulation (SVHC) and WEEE European legislation.

Typical material properties

CHARACTERISTICS	METHOD	UNIT	VALUE
Quantity of glass		%	20
Linear shrinkage	ISO 2577	%	0,1
Density	ISO 1183	g/cm ³	1,8
Water absorption	ISO 62 Met. 1	%	≤0,2
Flexural strength	ISO 14125A	MPa	90
Flexural modulus	ISO 14125A	MPa	10.000
Impact strength (Charpy)	ISO 179	KJ/m ²	30
Rockwell hardness	ISO 2039-2	HRm	80
Heat distortion temperature HDT	ISO 75	°C	≥200
Surface resistivity	IEC 93	Ω	10 ¹⁴
Volume resistivity	IEC 93	Ω mm	10 ¹⁴
Arc resistance	ASTM D 495	s	≥180
Oxygen index	EN ISO 4589-2	%	≥32
Smoke	EN ISO 5659-2 25kWm ⁻²	Ds max.	≤150
Toxicity	NF X 70-100-1 and -2	CIT _{NLP}	≤ 0,75
Glow wire	IEC 695-2-1	°C	960
Flammability	UL 94	Class / mm	V0 / 3.0

Properties were determined on compression-moulded specimens according UNIPLAST rules project 412 and 413

BMC RF 9/20



Polynt S.p.A.
Socio Unico
Sede Legale: Via Enrico Fermi n. 51 - 24020 Scanzorosciate (BG)
Registro Imprese di Bergamo e Codice Fiscale n. 04902660960/P.IVA IT04902660960 - R.E.A. di Bergamo n. 383079
Capitale sociale Euro 23.599.698,00 i.v.
Società soggetta all'attività di direzione e coordinamento da parte di Polynt Group Holding Inc.

THIS CERTIFICATE REMAINS THE PROPERTY OF CSI SPA

Attestato n° / Statement no.: C1344IDC\REA\20

Visti i rapporti di prova CSI n. 1344IDC\REA\20 e 0139/DC\TOX\20
Referring to the CSI test reports n. 1344IDC\REA\20 and 0139/DC\TOX\20

si dichiara che
this is to declare that

BMC RF 9/20
(Resina poliestere insatura caricata con cariche minerali e rinforzata con fibre di vetro)
(Glass fiber reinforced mineral filler added un-saturated polyester resin)

Fabbricato da:
Manufactured by

POLYNT SPA
VIA CADUTI E DISPERSI DELL'AERONAUTICA, 18
24030 BREMBATE DI SOPRA (BG)

è conforme alla norma
is found to comply with the standard

EN 45545-2:2013+A1:2015 requisiti R22-R23 per HL1, HL2 e HL3
per le prove T01, T10.03 e T12
EN 45545-2:2013+A1:2015 requirements R22-R23 for HL1, HL2 and HL3
for the tests T01, T10.03 and T12

Data di rilascio/certificate issue date: 25/11/2020

Ing. P. Fumagalli

Pag. 1/1

CSI S.p.A. - A 3000 UNED
Via Enrico Fermi, 51 - 24020 Scanzorosciate (BG)
Codice Fiscale 04902660960 - P.IVA IT04902660960

REA BG 14663/0
R.U. P. 01/13/2001/00011
Cap. Soc. € 1.046.000

Sede legale
36069 - 120000 Ferruzzi 108 | Caviglioglio Traversogno 21
Info@csi-spa.com | www.csi-spa.com



Marchio figurativo depositato



: Via F.lli Porcellaga 6
: 25122 Brescia
: tel +39 030 2592391

: elisabetta.squassina@metaelettrica.it
: antonio.baratto@metaelettrica.it

: www.metaelettrica.it



STA515-NOV19-E